

Eclipse79C (Soaker)

General Specifications

Installation	Freestanding
Material	High Gloss Acrylic Sheet Reinforced with Fiberglass and Resin
Weight	132 lbs - Soaker 142 lbs - Air Jet 150 lbs - Water Jet 162 lbs - HydroSpa
Depth to Overflow	14.80"
Water Capacity (with Bather*)	86 gal (61 gal)

Drain Requirement

Required pop-up drain and 1.5" drain hub included
Can use Slip Joint or Quick Connect Drain (Not Supplied)
Tub supplied with leveling pads for uneven floors

Tub Configurations

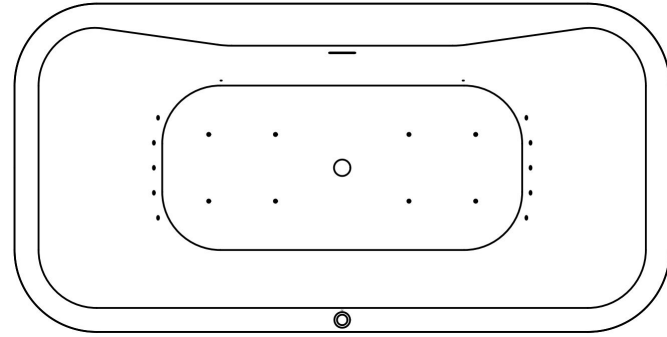

Eclipse79CAJ (Air Jet)

(Electrical: 1x 110V 15A GFCI)

Standard Feature: Air Blower

Optional Features: Chromotherapy Light, Ozone Sanitizing

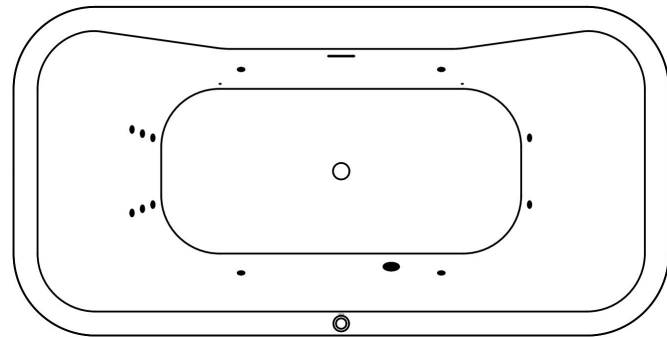

Eclipse79CWJ (Water Jet)

(Electrical: 1x 110V 15A GFCI)

Standard Feature: Water Pump

Optional Features: Chromotherapy Light, Ozone Sanitizing, Speed Control, Water Heater

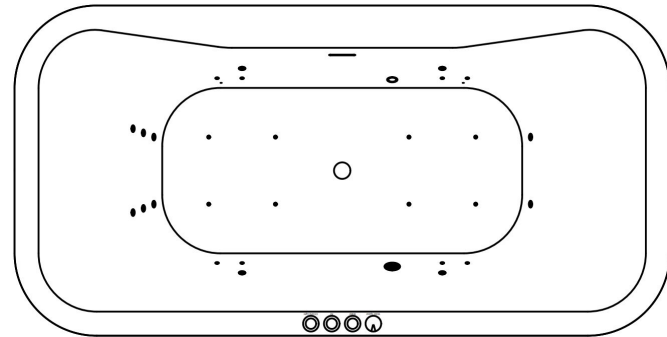

Eclipse79CHS (HydroSpa)

(Electrical: 2x 110V 15A GFCI)

Features: Air Blower, Water Pump, Water Heater, Speed Control, Chromotherapy Light, Ozone Sanitizing, Headrest Pillows

Component Legend

- Suction Cover
- Chromotherapy Light
- Water Jet
- Air Wall Jet
- Air Floor Jet

Codes/Standards

ASME A112.19.702020/CSA B45.10:20*
CSA B45.5/IAPMO Z124-2017
UL 1795*
MA Code Accepted

