

For faucet rough-in, please view the specification sheet for the faucet purchased

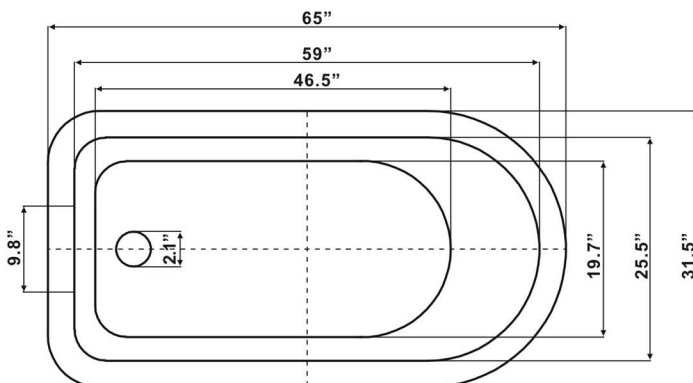

Meets or Exceeds ANSI Z124.1.2-2005; CSA B45.0-02 & CSA B45.5-02

Weights

Weight empty	154 lbs
Weight filled to overflow	524 lbs
Gallons to overflow	58

General

- Reinforced extra thick floor
- Slip resistant floor
- High gloss interior and exterior
- Integrated aluminum heat barrier
- Minimum tub thickness 3/4"

cUPC label on base of tub



MA Code Accepted
Universal Plumbing
Code Listed

Manufactured by;

Baths of Distinction Inc. 5843 Carrier St, St. Petersburg, Florida USA 33714