

Copper Shell French Bateau 59"

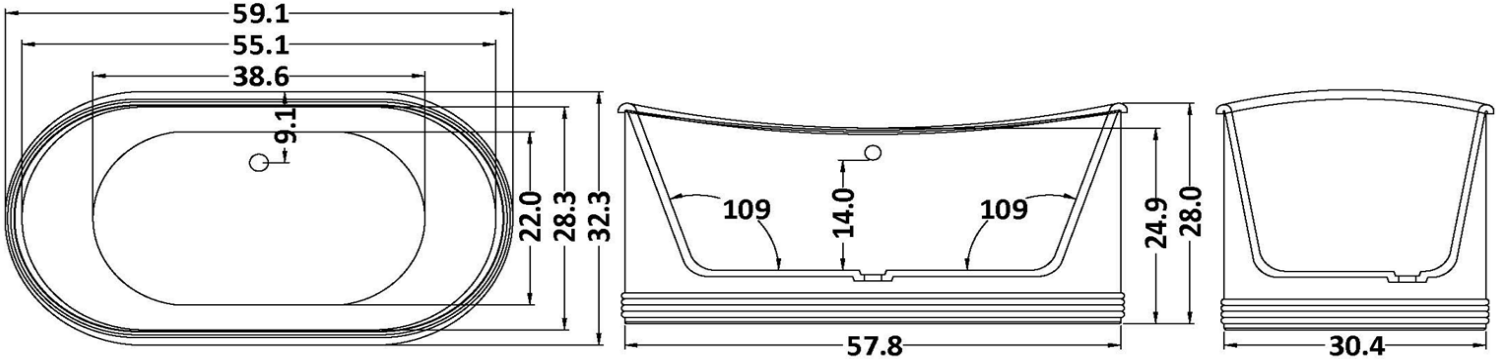

Freestanding Bathtub Name & Length	Copper Skirt	59"		
Integrated Drain Position	Back Center			
Features	Soaker	Air Jetted	Water Jetted	Spa Jetted
Model Number	CopEWSBT59	CopEWSBT59A	CopEWSBT59W	CopEWSBT59HS
Pop-up Drain	yes	yes	yes	yes
Drain Hub	yes	yes	yes	yes
Integrated Jetting Parts	N/A	yes	yes	yes
Speed and Direction Control Water Jets	N/A	N/A	4 Sides + 2 Feet	4 Sides + 2 Feet
Direction Control Only Water Jets	N/A	N/A	4 Back	4 Back
Variable Speed Heated Air Jets on Floor	N/A	12	N/A	12
Water Heater	N/A	N/A	Optional	yes
Chromotherapy Light	N/A	Optional	Optional	yes
Ozone Sanitizing	N/A	Optional	Optional	yes
Remote Control Operation (no buttons)	N/A	yes	yes	yes
Additional 6' Electrical Extensions	N/A	yes	yes	yes
Cord Location	N/A	Customer Specify	Customer Specify	Customer Specify
Tub Weight Empty lbs	194	198	206	210
Gallons to Overflow with Bather	40	40	40	40
110 volt - GFCI Requirement On Site	none	1 - 15 amp	1 - 15 amp	2 - 15 amp

The speed control water jets can be easily adjusted or turned off to increase the back jet pressure for a more aggressive back massage.

Meets or Exceeds

CSA B45.5/IAPMO Z124-2017
ASME A112.18.1-2018/CSA B125.1-18
MA Code Accepted

cUL Listed



www.bathsofdistinction.com