

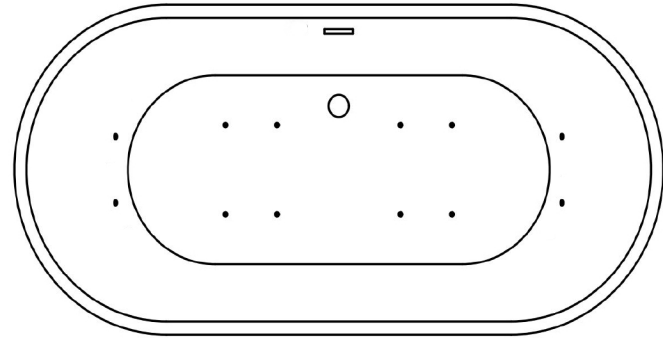

Tub Configuration

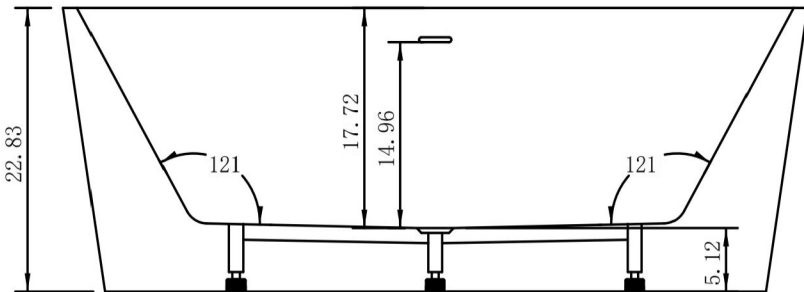

Napoli63CAJ (Air Jet)
(Electrical: 1x 110V 15A GFCI)

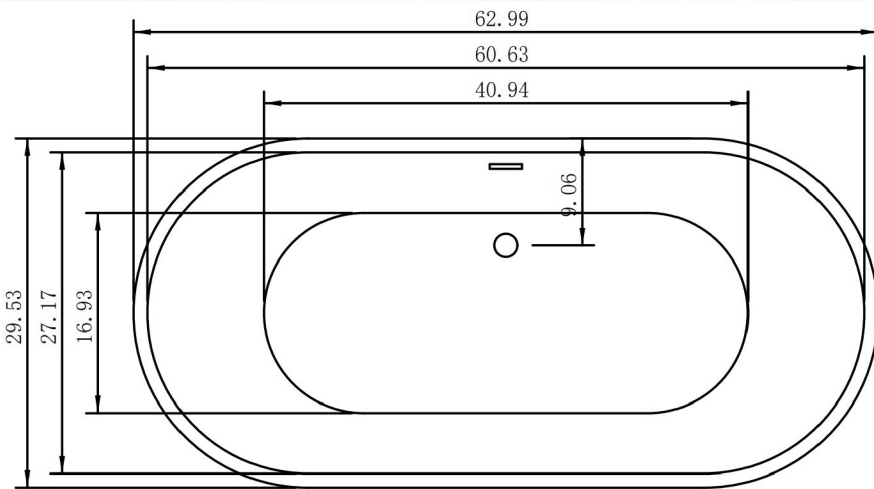

Napoli63C (Soaker)

General Specifications

Installation	Freestanding
Material	High Gloss Acrylic Sheet Reinforced with Fiberglass and Resin
Weight	107 lbs - Soaker 117 lbs - Air Jet
Depth to Overflow	14.96"
Water Capacity (with Bather*)	68 gal (43 gal)

Codes/Standards

ASME A112.19.702020/CSA B45.10:20*
CSA B45.5/IAPMO Z124-2017
UL 1795*
MA Code Accepted
All Electrical Components UL Listed