

**Baths of Distinction Inc.**  
764A Anclote Rd  
Tarpon Springs  
Florida  
USA 34689  
www.bathsofdistinction.com

Manufacturers of  
**Classically Styled Vintage Bathtubs**

## INSTRUCTION & INSTALLATION MANUAL

*Congratulations on your purchase of a fabulous bathtub from **Baths of Distinction Inc***



**Classique**™ Non-Jetted Clawfoot Bathtubs



**SanSiro**™ HYDROMASSAGE Jetted Clawfoot Bathtubs  
*Pump with Air Intake Control*



**Empress**™ HYDROTHERAPY Jetted Clawfoot Bathtubs...  
*Pump with Heater, Air Intake, Chromotherapy, Aromatherapy, Ozone Disinfecting, Jet Flow Control*

SERIAL NUMBER

---

MODEL

---

DATE MANUFACTURED

---

DATE INSTALLED

---

### WARNING

**This Instruction & Installation Manual shall be removed only by the final user, prior to using this unit.**

## TABLE OF CONTENTS

Tub Serial Number Details _____	Page 1
Table of Contents _____	Page 2
Warranty _____	Pages 3 & 4
Safety _____	Page 5
Technical Leveling & Installation _____	Page 6
Technical Plumbing _____	Page 7
Technical Electrical _____	Page 8
Technical Operating _____	Pages 9, 10 & 11
Care & Maintenance _____	Page 12
Warranty Registration _____	Page 13
Ozone Disinfecting _____	Page 14
Aromatherapy & Chromotherapy _____	Page 15
Jet Style & Placement _____	Page 16

## WARRANTY

**Baths of Distinction Inc.** offers one of the most comprehensive warranties in the industry. When you purchase one of our bathtubs, we want you to have total peace of mind.

### **TEN Year Limited Warranty**

**Baths of Distinction Inc.** (the "Company") extends a non-transferable limited warranty to the original purchaser (the "User") who purchases the unit for personal or single family residential use as follows;

**Limited TEN (10) Year** warranty on the structural integrity of the inner and outer acrylic shells of the tub.

**Limited TWO (2) Year** Parts warranty on all factory fitted components to include the pump, motor, heater and factory supplied and installed faucet and plumbing parts.

**Limited ONE (1) Year** Labor warranty where the company shall, at its election, send a technician or locally appointed service company to repair or replace any failed factory fitted component as described above due to workmanship.

**Limited TWO (2) Year** Parts warranty on the faucet whereby the company shall, at its election, send the user either a replacement cartridge, part or entire faucet.

The Company warranties can only be transferred if purchased by a developer or builder and on receipt of prior written confirmation of such by the company.

Warranty coverage commences on the date the unit was originally purchased by the user and upon receipt by the company of a completely filled out Warranty Registration Document as described herein.

### **Warranty Exclusions and Limitations**

The limited warranty shall not cover, without limitation, damage from failure to install in accordance with the company's instructions, fading from exposure to direct sunlight, damage from improper handling, abuse, misuse, neglect, accident or natural disaster, damage due to improper handling, installation or subsequent movement after initial installation, alteration from original design or failure to follow company recommended maintenance and cleaning, metallic coated or plated hardware and light bulbs, defects, damage or failure caused by the common carrier, installer, user or other person, pets, or rodents. In addition, the company shall not be responsible for incidental damage or consequential damages or losses arising from any cause including but not limited to water damage to carpet, ceiling, tiles, marble, wood flooring, loss of use etc., including its own negligence.

Warranty coverage is provided in the 48 Continental United States only.

### **Exclusion of Implied Warranties**

Implied warranties or merchantability and fitness for a particular purpose are disclaimed altogether or to the fullest extent allowed by law. There are no warranties applicable to the SanSiro bathtubs except as expressly stated herein or as implied by applicable state and federal laws. Some states do not allow limitations on how long an implied warranty lasts, or the exclusion or limitation of special, incidental or consequential damages, so these limitations and exclusions may not apply to you. This warranty gives you specific legal rights. You may also have other rights which vary from state to state.

## WARRANTY

### Responsibilities of Others

The company is not responsible for costs to modify any product to obtain any code approvals, such as city, county or state building codes in the USA.

### Warranty Card Registration

In order to validate this warranty, the warranty registration card must be completely filled out and returned within 30 days from original purchase date. Warranty registrations can be completed on the internet by logging on at [www.bathsofdistinction.com](http://www.bathsofdistinction.com)....**Warranty Registrations**

### Warranty Service

As well as its' own factory trained technical staff, the company maintains a list of independent service personnel to perform required warranty service repairs. Such firms are not agents or representatives of the company and cannot bind the company by words or conduct. The company will provide the warranty service described herein when the following conditions have been met:

- a) the failure is of a nature or type covered by the warranty
- b) the user has informed the company of the nature of the problem during the warranty period.
- c) In order to obtain warranty service, please contact **Baths of Distinction** through the technical help line at [www.bathsofdistinction.com](http://www.bathsofdistinction.com). All replacement parts, equipment, and repairs shall assume the remaining warranty period of the parts replaced. The company's warranty obligation shall be discharged upon tender of replacement or repair.

## SAFETY

### IMPORTANT SAFETY INSTRUCTIONS

**Please carefully read and follow all instructions prior to installing and using your bathtub.**

- 1. DANGER:** To reduce the risk of injury or drowning, do not permit children to use this unit without adult supervision.
- 2. DANGER:** Do not submerge your head under the water or wash your hair in the bathtub with the jets running.
- 3. WARNING:** Do not use alcohol, drugs or medication before or during the use of a bathtub.
- 4. WARNING:** Do not allow appliances such as a hair dryer, lamp, radio etc. within 5 feet of this bathtub. RISK OF ELECTRIC SHOCK.
- 5. WARNING:** There is a risk of hyperthermia and possible drowning with a water temperature in excess of 38° C. This temperature may also be injurious to your health if you are suffering from certain medical conditions. Please consult your physician if you are in any doubt.
- 6. WARNING:** If you suffer from headache, dizziness or nausea, get out of the bath and take a cool shower. You may be suffering from hyperthermia if the water in your bath has been too hot. If the problem persists, please consult your doctor.
- 7. WARNING:** Pregnant women, people using medications or having an adverse medical history should consult a physician before using a hydromassage or hydrotherapy bath.
- 8. WARNING:** Test all ground fault circuit interrupter (GFCI) switches in accordance with the manufacturers instructions.

**PLEASE RETAIN THESE INSTRUCTIONS**

## TECHNICAL

EVERY ASPECT OF EVERY TUB THAT LEAVES THE BATHS OF DISTINCTION FACTORY HAS BEEN FULLY TESTED BEFORE PACKING

### LEVELING

**Note:** To ensure correct usage and enjoyment of your tub, it important to correctly level your bathtub.

1. Position your tub where it will be situated.  
Adjust the leveling bolts at the base of the leg to make level. (see diagram)

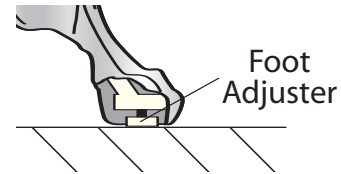

### INSTALLATION & TESTING

**NOTE:** When you receive your tub, your faucet, drain cover, drain connector and any special order products like the Aromatherapy sample kit will be attached in a box to the base of the crate. Please check to ensure that all ordered parts are included.

1. Before filling your tub with water, clean out any debris that may have gathered inside it.
2. After following the electrical and plumbing instructions, activate your water valves and electricity.
3. The tub shall be tested. Fill the tub with water to just above the overflow. CHECK to make sure that there are no leaks from the overflow, these will be apparent from the bottom of the tub at the drain.
4. Turn the overflow cover to open your drain and allow a little water to drain out of your tub, but still retain the water level at least 2 inches above the jet nozzles. While draining, check to see if there are any leaks from the drain and repair appropriately.
5. After closing the drain, activate the pump. Allow the jets to run for five minutes and check again for any leaks. Any leaks will be apparent from the bottom of the tub.
6. At this time, you can also activate and check all the options you may have chosen for your tub, like select-a-flow, chromotherapy, aromatherapy, air intake control etc.
7. Options such as heater and ozone disinfecting will operate in conjunction with the pump and will have been fully tested before leaving the factory.

## TECHNICAL

### PLUMBING

**NOTE:** Follow all Local Regulations for plumbing in.

#### a) Hot & cold Supply

Unless your tub is purchased without a faucet, the faucet connectors with flexible supply hose will be fitted to your tub.

It is recommended that the flexible 1/2" hot & cold supply lines are connected to stop valves that would be concealed either under or behind the tub. Valves should still remain easily accessible.

Baths of Distinction Inc.  
*Hot & Cold Water Supply Lines*

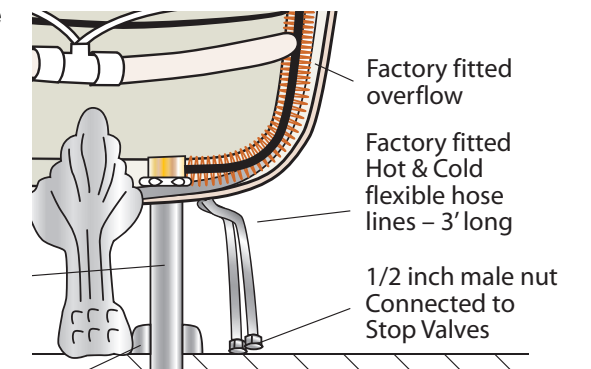

#### b) Faucet Assembly & Connection

Assemble the faucet as per instructions and attach to the tub connectors as per diagram.

Use PTFE tape on the threads and when using the wrench, use a protective cloth to protect the coating on the connector nut.

Baths of Distinction Inc.  
*Faucet Assembly to Tub*

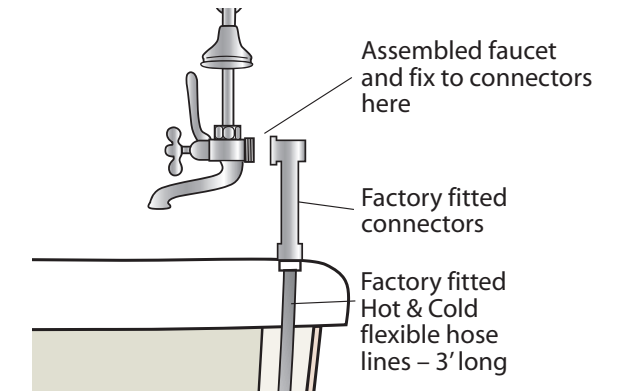

#### c) Drain & Overflow Connection

The overflow is built into the tub and connects directly to the drain pipe. No further work is required on this.

To connect the drain to the floor drain, use a straight 1.5" connection pipe as shown.

**Note:** The tub drain should be positioned directly over the floor drain to make a straight connection.

Baths of Distinction Inc.  
*Floor Drain Connection*

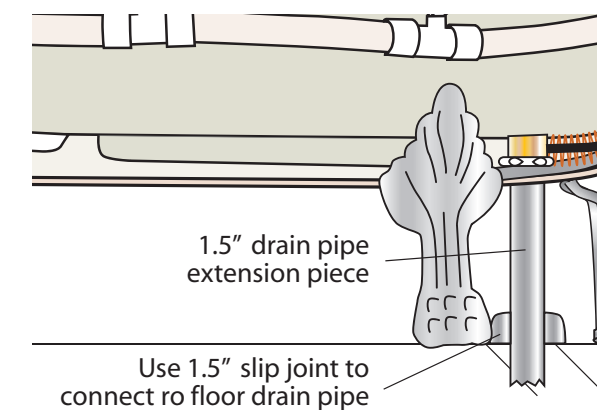

**TECHNICAL  
ELECTRICAL**

**ALL ELECTRICAL INSTALLATIONS SHOULD BE CARRIED OUT BY A QUALIFIED LICENSED CONTRACTOR IN ACCORDANCE WITH LOCAL CODE REQUIREMENTS.**

**ELECTRICAL INSTALLATION INSTRUCTIONS**

**WARNING:** Please take basic precautions when using electrical products, including the following:

- a) **DANGER:** Risk of Electric Shock ONLY connect to a circuit protected by a ground fault circuit interrupter Class A. (GFCI)
- b) **Grounding is required.** The unit should be installed by a qualified electrician and grounded.
- c) **Access for servicing** is achieved by separating the inner shell from the inner shell (see diagram p11)

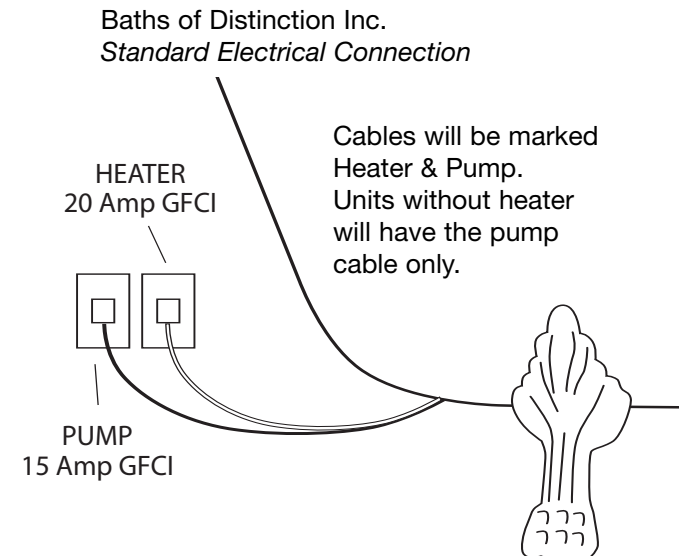

1. Turn off all power supply before commencing the electrical installation
2. The PUMP is designed for use with an independent 15 amp, 120V electrical power supply, protected by a GFCI Class A.
3. The HEATER is designed for use with an independent 20 amp, 120V electrical power supply, protected by a GFCI Class A. The HEATER is not designed to heat up water from cold. It will automatically engage when the pump and jets are working. It is specifically designed to maintain the water temperature of your tub.
4. Never use an extension wire. The electrical connection must be permanent and in accordance with local regulations.
5. Each system of your bath must be connected to an independent Class A GFCI.
6. If your tub has the OZONE disinfecting system, please see electrical connection diagram.

**ELECTRIC INSTALLATION  
PUMP WITH OZONE**

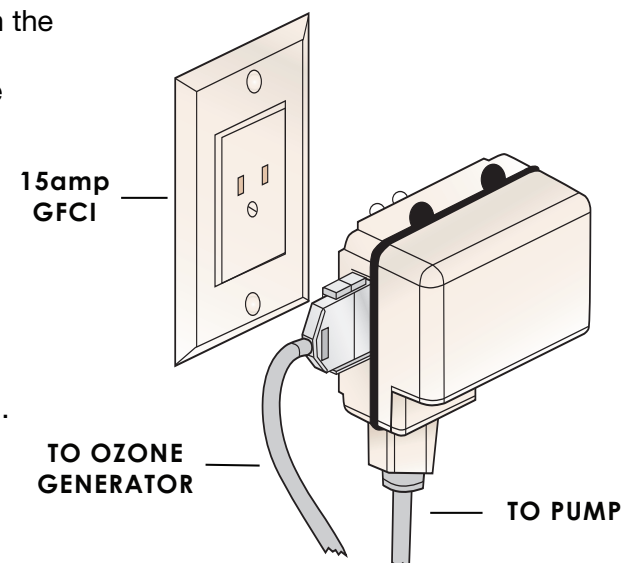

**TECHNICAL  
OPERATING**

**NOTE:** Depending on the tub and accessories you have purchased, the following describes the use of each function.

1. **PUMP:** If JETTED, your new Baths of Distinction Jetted Bathtub is fitted with a 1.5hp motor. Press the air switch marked PUMP to activate the jets.
2. **HEATER:** The heater on your tub is designed to maintain the water temperature while the jets are operating. It is not designed to heat the water from cold. The heater will work when the jets are operating.
3. **OZONE:** If your unit has the OZONE disinfecting option, this will automatically engage every time the jets are run.

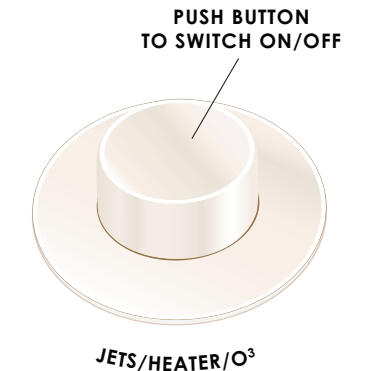

4. **AIR INTAKE:** When the pump is operating and the jets are running, you can adjust the air intake into the water flow by turning the valve top on the AIR Switch.

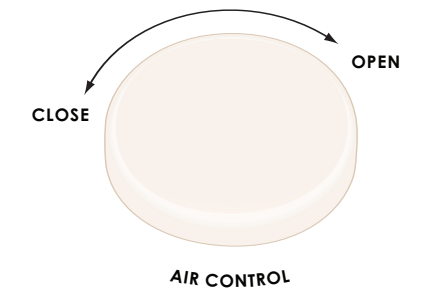

5. **SELECT-A-FLOW:** If your tub has the Select-A Flow option, you can adjust the flow rate of your pump from fast to slow to allow for a soft or strong massage. There are three settings on this function.

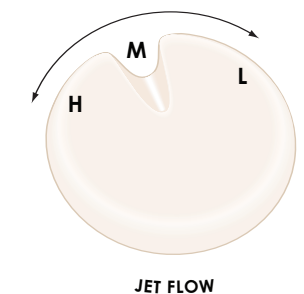

6. **CHROMOTHERAPY:** If your tub has the chromotherapy option, you will need to press the control button to activate. The Chromotherapy color choice will change each time you press the button ON & OFF, allowing you to settle on the color to suit your mood.

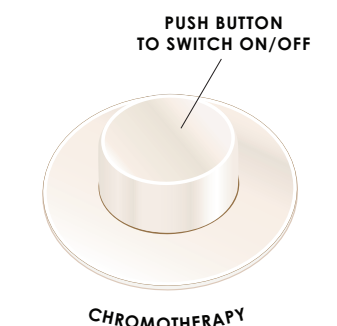

**TECHNICAL  
OPERATING**

**7. AROMATHERAPY**

If your tub has the Aromatherapy option, you will need to soak and install the wicking strip into the Aromatherapy holder. When you run the jets, the air intake will infuse your water with the aroma you have chosen. Follow the instructions on your sample kit. For further aromatherapy supplies, you can contact the company on the free supply pack.



**Aromatherapy Infuser**



**Aromatherapy Oil Sample Pack**



**8. SIDE JETS**

The jets on the side of your new tub are adjustable for both direction and individual pressure control. To adjust the direction, simply move the toggle in the center of the jet in the desired direction. To control the speed, turn the jet cover by holding the outside and turning to reach the desired flow speed.

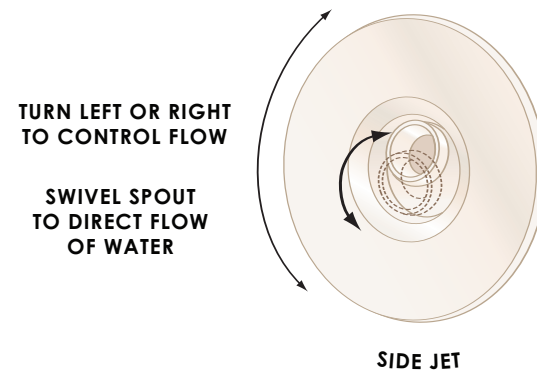

**9. FOOT PULSE JETS:**

The foot pulse jets are not directionally adjustable, but they can be controlled for strength in the same manner as the side jets. Unlike the side jets, the pulse jets offer a pulsing motion that is especially soothing on tender areas of the feet.

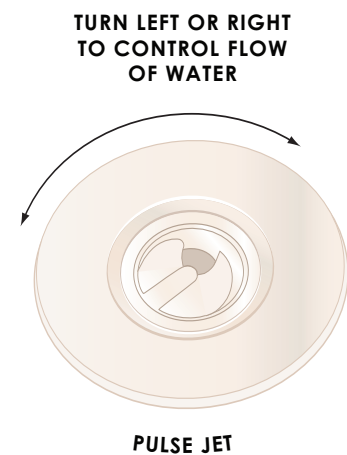

**TECHNICAL  
OPERATING**

**10. SINGLE LOWER LUMBAR MICRO JET**

(optional 59", 67" & 73") If your tub has the Lower Center Back Micro Jet, this jet is not adjustable in either speed or direction. It will operate at a fixed strength to massage the lower lumbar area of the back.

This jet is positioned at the lower arched area of the back in the center of the tub.

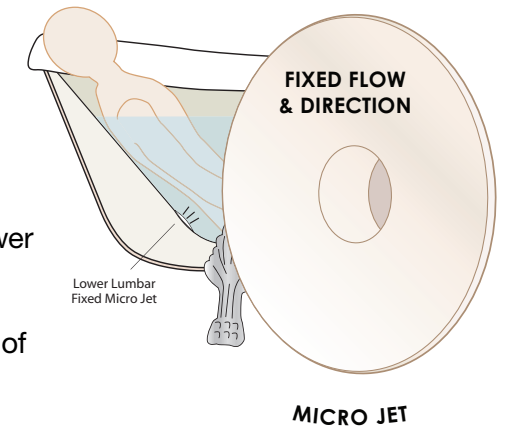

**11. DOUBLE ENDED 75" TUB BACK MICRO JETS**

These back micro jets are fixed for strength and direction. There are four back jets on the 75" double ended tub.

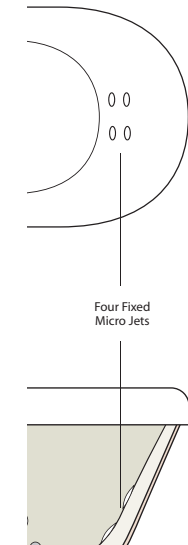

**12. DOUBLE ENDED 75" TUB FOOT or LOWER LUMBAR BACK JETS.**

There are two micro jets on the opposite end of the 75" double ended tub. As described, the bather can move position to use these for either lower lumbar massage or foot massage. These micro jets are fixed for both direction and strength.

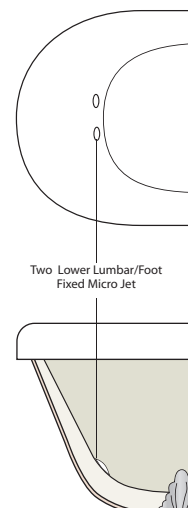

## MAINTENANCE INSTRUCTIONS

**1. ACCESS:** To obtain access to any working part of your tub, simply disconnect from the drain and water connections. Disconnect electrical. Unfasten the screws discreetly hidden under the roll top lip of the inner shell of your tub. The inner shell then lifts out to give you complete access to all working parts.

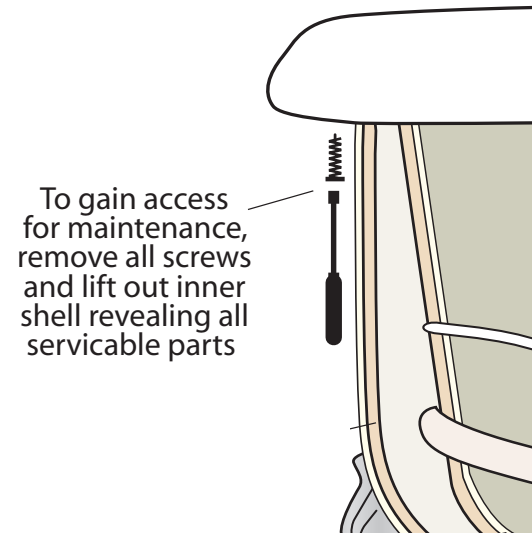

**2. APPROVALS:** Your new **Baths of Distinction** bathtub is UL approved. All **Baths of Distinction** bathtubs are manufactured in accordance with the requirements of ASME A112.19.7M. The Handheld Shower meets the double check valve requirement and regulated flow rate of ASME A112.18.3/CSA B125. Your **Baths of Distinction** OZONE system is NSF Certified and UL Recognized. All electrical parts are UL Listed.

### GENERAL CARE

**Warning;** In order to preserve the glossy acrylic finish of your new bathtub, never use abrasive cleaners containing a scouring powder. Never use steel wool, acetone, window cleaning products, ammonia, paint thinner, mineral oil on your bathtub or fixtures or trim.

- 1. Cleaning your Bathtub;** Clean your bath after each use. A soft sponge and a liquid detergent like Simple Green, Greased Lightning etc. with warm water will serve to maintain the cleanliness of your tub. Make certain that your chosen detergent is suitable for use on acrylic surfaces.
- 2. Disinfecting your Tub & Pipes.** On jetted tubs, please follow these recommendations;
  - a) Fitted with Ozone Disinfecting; Your Ozone disinfecting system will automatically and naturally sanitize your bath water during each bathing experience.
  - b) Non-Ozone; For jetted tubs without Ozone, it is recommended that every month, you fill your tub with warm water above the jets and add a cup of household bleach. Start your jets and allow to run for five minutes. Empty the tub and refill with cold water, repeating the jet operation for rinsing before emptying ready for use.

## WARRANTY REGISTRATION

There are two options to register your tub warranty.

1. Sign on at [www.bathsofdistinction.com](http://www.bathsofdistinction.com) and complete the warranty information as shown under the heading WARRANTY REGISTRATION.
2. Complete the document at the bottom of this page and return it to;

**Baths of Distinction Inc.**  
 PO Box 40  
 Ozona  
 Florida 34660

**PLEASE CUT OUT AND RETURN TO US THE ABOVE ADDRESS. Thank you.**

### WARRANTY REGISTRATION

#### PRODUCT INFO

Model \_\_\_\_\_ Serial number \_\_\_\_\_

Date of Purchase \_\_\_\_\_

Purchased from \_\_\_\_\_

#### PURCHASER INFORMATION

Name \_\_\_\_\_

Address \_\_\_\_\_

Telephone \_\_\_\_\_

## OZONE DISINFECTING

- 1. Ozone Sanitation:** The **Baths of Distinction** OZONE sanitation system infuses oxidation potential into the recirculating bath water. Ozone helps eliminate Bacteria in whirlpool and jetted bathtubs.
- 2. How the Ozone System Works:** When the tub jets are recirculating, the ozone generation begins in unison. Ozone gas is generated and immediately mixed into the recirculating bath water via the connection between the generator and the ozone therapy jet. When the jet pump is turned off, the ozone generator circuit is also turned off.
- 3. How the Ozone Generator Creates Ozone:** The Ozone generator splits Oxygen O<sub>2</sub> molecules into separate O<sub>1</sub> atoms. The O<sub>1</sub> atoms immediately bond loosely to adjacent O<sub>2</sub> molecules to form powerful O<sub>3</sub> Ozone molecules.
- 4. Reliability:** The **Baths of Distinction** Ozone generator system is NSF Certified and UL Recognized.
- 5. The Benefits of the Ozone System:** The Ozone system helps neutralize sediments such as soaps, body oils, and other organic and inorganic materials that may be found in bath water. It significantly reduces organic build-up and microbial growth in plumbing. It is environmentally friendly and will not irritate, dry out nor leave a chemical film on the skin.
- 6. The Baths of Distinction** Ozone System meets the NSF Protocol P308 for Ozone Sanitation Systems for Jetted Bathtubs.

## CHROMOTHERAPY & AROMATHERAPY

### CHROMOTHERAPY

Chromotherapy lighting is available as an option on all jetted tubs manufactured by **Baths of Distinction**. It is also a STANDARD Feature on our Empress Line of Hydrotherapy Bathtubs.

- 1. Our Chromotherapy Light** has a clear lens and an intelligent light bulb that produces **many colors and color patterns**.
- 2. Choice of Color:** Each time you press the operating button on and off for the Chromotherapy, a new color will appear. There is also an option for the colors to move in a cycle, alternating frequently from one to another.
- 3. Color Representation:** Light and light impact have an effect on the human psyche. These are some of the problem areas that can be positively affected by differing light colors.
  - **White:** Alertness & Blood Circulation
  - **Red:** Lumbar & Cervical pain
  - **Pink:** Heart, Circulation, Asthma
  - **Crimson:** Stiffness of the Neck, Cold Feet
  - **Orange:** Arthritis, Constipation.
  - **Peach:** Digestion, Thyroid.
  - **Yellow:** Food Allergy
  - **Green:** Colitis, Weight, Hypertension
  - **Blue:** Cramps, Coordination, Tension
  - **Purple:** Migraines, Headaches.

### AROMATHERAPY

Aromatherapy Infusion is available as an option on all jetted tubs manufactured by **Baths of Distinction**. It is also a STANDARD Feature on our Empress Line of Hydrotherapy Bathtubs.

- 1. Air Canister Aromatherapy Infusion.** This allows for air infused introduction of aromatherapy fragrances rather than just adding aromatherapy oils to your bathtub. **Baths of Distinction** use this system and it works in conjunction with the Air Intake Valve on all jetted tubs. The aroma and essence from the Aromatherapy oils infuses the air intake into the jetted lines and allows for the fragrant aroma to fill the room and enhance the bathing experience.
- 2. Simple to Use:** Just soak the wicking strip and insert into the Aromatherapy infuser. On completion of your bath, remove the wicking strip and dispose of it. Each **Baths of Distinction** Jetted Tub with Aromatherapy will be supplied with a sample pack of Aromatherapy oils and wicking strips. Further orders can be placed directly with the sample pack manufacturer.
- 3. Fragrance Representation:** Each fragrance works to stimulate different senses.
  - Anti Stress: **Lemon**
  - Calming, Relaxing, Soothing Headaches: **Lavender**
  - Romance: **Jasmine or Rose**
  - Energy: **Peppermint Eucalyptus**
  - Tranquility: **Chamomile**
  - Depression: **Basil**



# Baths of Distinction—Jet Style & Placement

SLIPPER STYLE  
CLASSIQUE/SANSIRO/EMPRESS

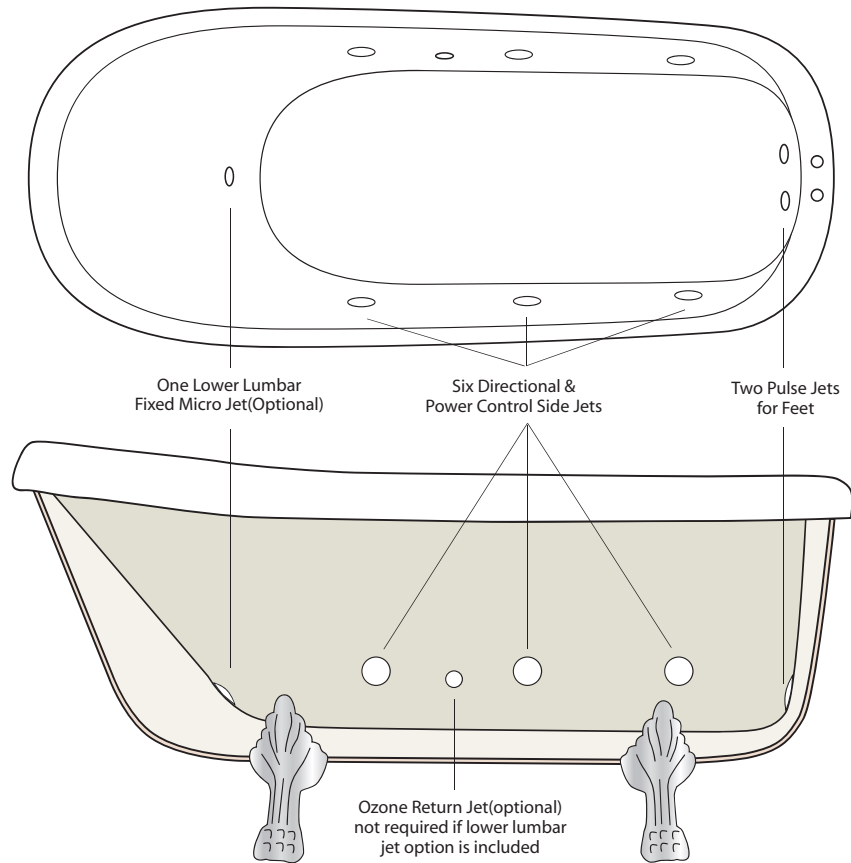

DOUBLE-ENDED  
CLASSIQUE/SANSIRO/EMPRESS 75"

